

Technical specification sheet

HMD 2 | FlowPanel Control Manifold

Specifications		
article number		100.172.044
model		HMD 2
short description		FlowPanel Control Manifold
number of outlet ports		2
couplers		yes
pressure gauge		yes
acting type		double
weight, ready for use	lb	22.0

Technical drawing dimensions		
dimension A	in	9.4

Standard supplied with	
• Couplers	
• Gauges	

Accessories	
Assembly Set Flowpanel HMD On Vari Pump	100.182.112
Assembly Set Flowpanel HMS On Vari Pump	100.182.111

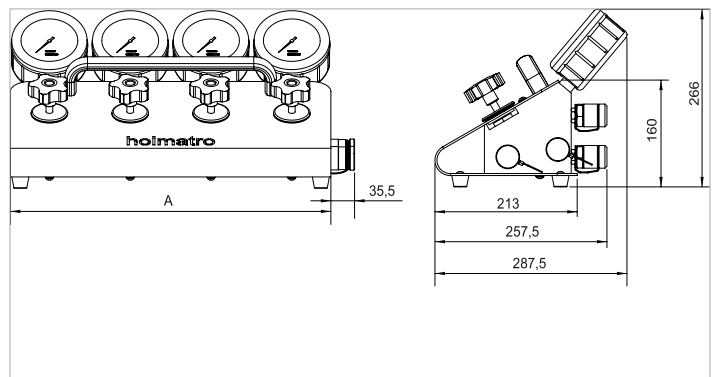

holmatro.com

© Holmatro 2025-10-02

While the greatest care has been devoted to the content, it is possible that the information in this printed matter is incorrect or incomplete. Holmatro B.V. and its affiliated companies (hereafter: Holmatro) cannot be held liable in any way for the consequences of activities undertaken on the basis of this printed matter. Values can vary within the manufacturer measurements. If you have any doubts about the correctness or completeness of the information, you shall contact Holmatro (T +31 (0)162-751480). Nothing from this printed matter can be copied and/or made public in any way without the explicit authorisation of Holmatro.