

Technical specification sheet

HVLW 16 S 2 | Vertical Lifting Wedge

Specifications		
article number		100.112.104
model		HVLW 16 S 2
max. working pressure	psi	10443
short description		Vertical Lifting Wedge
max. spreading force	lbf	35205
tonnage	lb	35274.0
min. insertion space	in	0.4
lifting stroke	in	0.8
required oil content (effective)	oz	2.5
return type		spring
weight, ready for use	lb	19.4

Standard supplied with

- Safety block
- Step block
- Grease pistol
- Grease cartridge Molycote®
- Plastic carrying / storage box

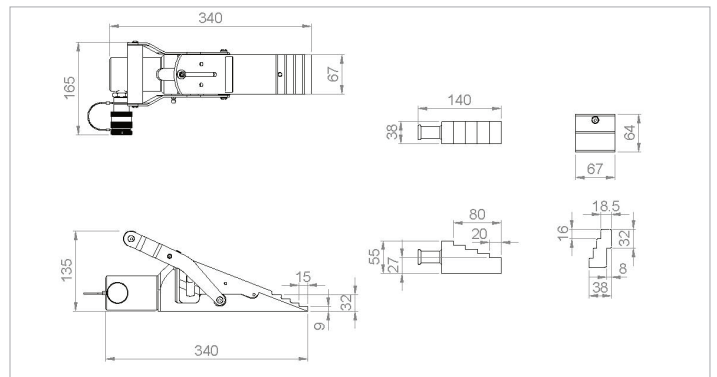

holmatro.com

© Holmatro 2025-10-01

While the greatest care has been devoted to the content, it is possible that the information in this printed matter is incorrect or incomplete. Holmatro B.V. and its affiliated companies (hereafter: Holmatro) cannot be held liable in any way for the consequences of activities undertaken on the basis of this printed matter. Values can vary within the manufacturer measurements. If you have any doubts about the correctness or completeness of the information, you shall contact Holmatro (T +31 (0)162-751480). Nothing from this printed matter can be copied and/or made public in any way without the explicit authorisation of Holmatro.