

Technical specification sheet

HWJ 25 U | Wedge

Specifications		
article number		100.102.021
model		HWJ 25 U
short description		Wedge
max. working pressure	bar/Mpa	720 / 72
tonnage	t	24
min. insertion space	mm	6
lifting stroke	mm	51
max. spreading force	kN/t	235.4 / 24
return type		hydraulic
required oil content (press)	cc	328
required oil content (retract)	cc	217
weight, ready for use	kg	8.1

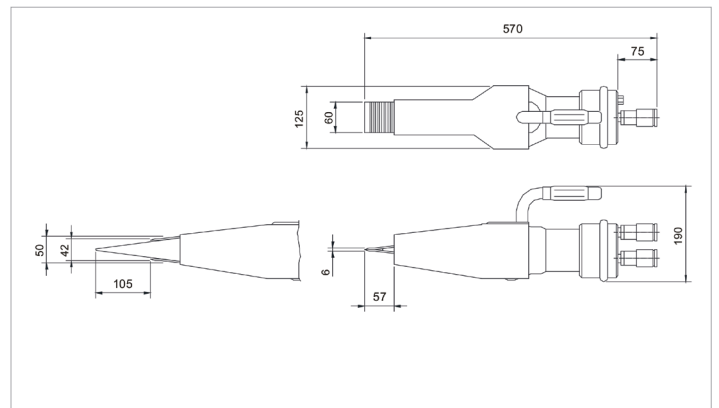

holmatro.com

© Holmatro 2025-10-01

While the greatest care has been devoted to the content, it is possible that the information in this printed matter is incorrect or incomplete. Holmatro B.V. and its affiliated companies (hereafter: Holmatro) cannot be held liable in any way for the consequences of activities undertaken on the basis of this printed matter. Values can vary within the manufacturer measurements. If you have any doubts about the correctness or completeness of the information, you shall contact Holmatro (T +31 (0)162-751480). Nothing from this printed matter can be copied and/or made public in any way without the explicit authorisation of Holmatro.